

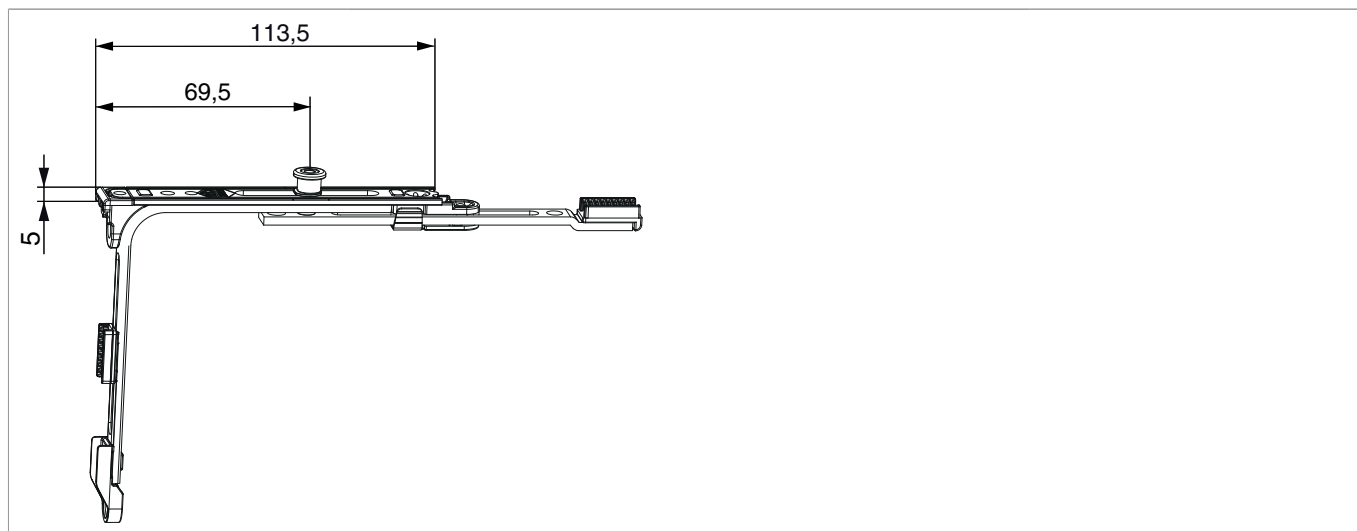



## 222203 - Eckumlenkung MM kurz mit 1 i.S. FFB 220-319 Silber



### Technische Zeichnung



		B	H				N <sup>o</sup>
Silber	kurz mit 1 i.S.	113,5	5	220 - 319	275 - 359	50	222203 <sup>0)</sup>

<sup>0)</sup> Senkkopfschraube M4x8 mm selbstformend, Art. Nr. 101339 beige packt.



### Schraubpositionstabelle

N <sup>o</sup>		1	2		3	4	
222203	2	106,5	121,5	1	106,5		

### Zapfensitztable

N <sup>o</sup>		Z1		Z2	
222203	1	69,5	0		

### Lehren

						N <sup>o</sup>
Einlegelehre für Mittelverschluss und Schere MM	mit Halter 48 mm		260 - 1.500	270 - 2.000	1	204771
Einlegelehre für Riegel-schließeteil mittig MM-KS		2-flg.			1	213865

## Stützbockverschraubung

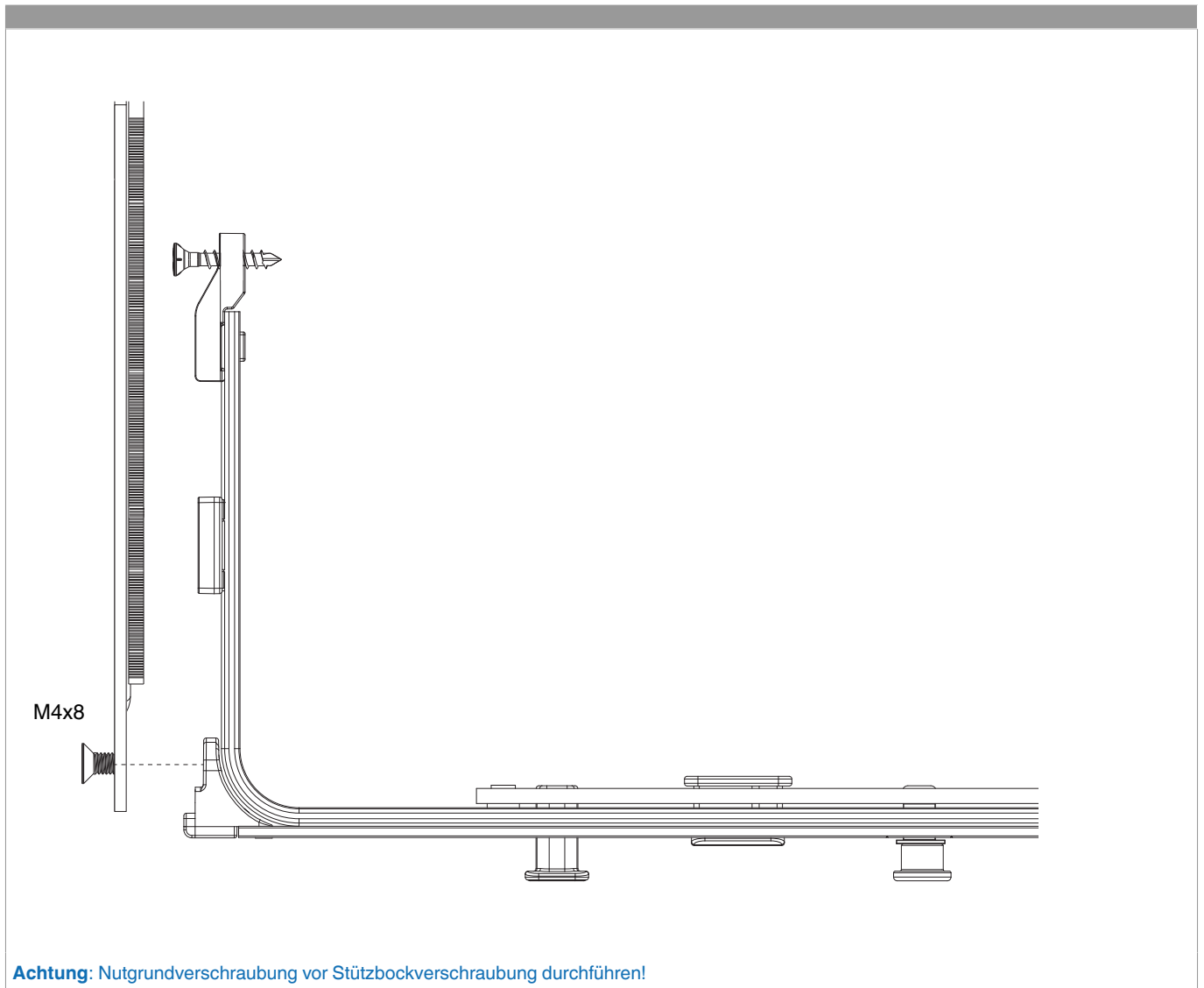

## Anpressdruckeinstellung

i.S Zapfen und Verschlusszapfen

