

TS 4000  
TS 4000 S



107754-04



**A**

**B**

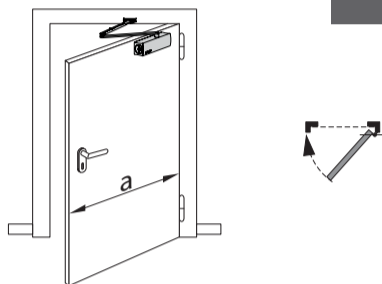
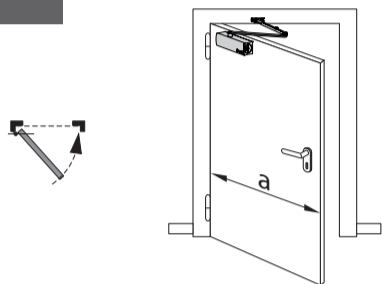

TS 4000/4000 S  $a \leq 1400$  mm  
TS 4000 EN 5-7  $a \leq 1600$  mm

TS 4000/4000 S  $a \leq 1400$  mm  
TS 4000 EN 5-7  $a \leq 1600$  mm

**1**

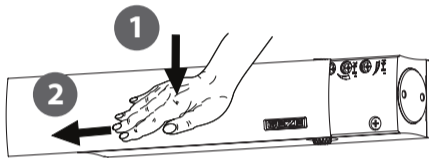

**2**

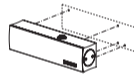
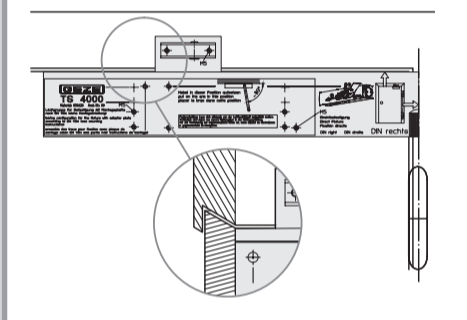
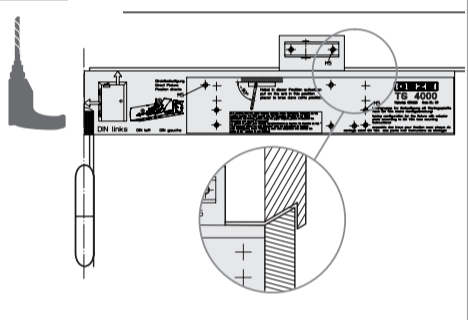

[mm]

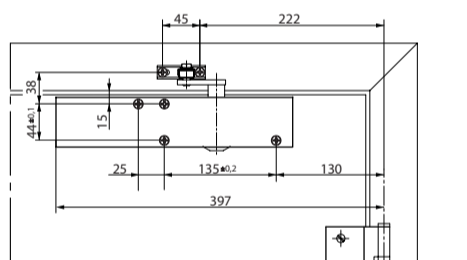
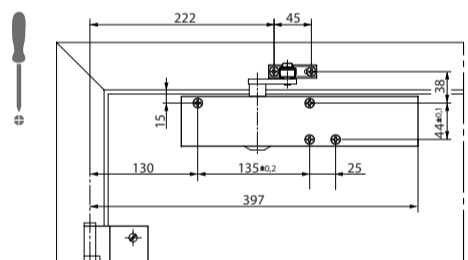

4x  
5x60  
4x  
M5x55

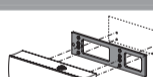

[mm]

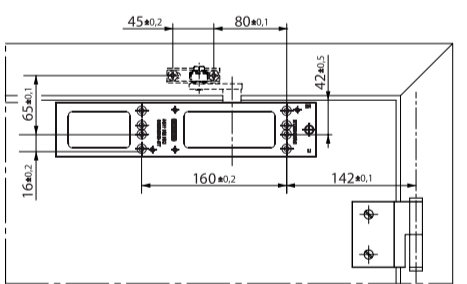
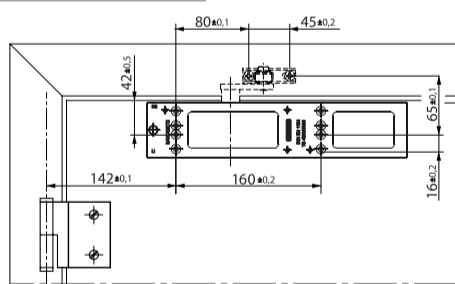

4x  
5x35  
4x  
M5x20

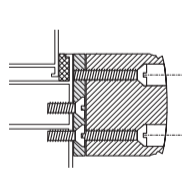
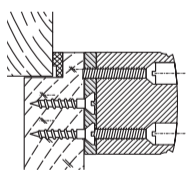

3x  
M5x45

**3**

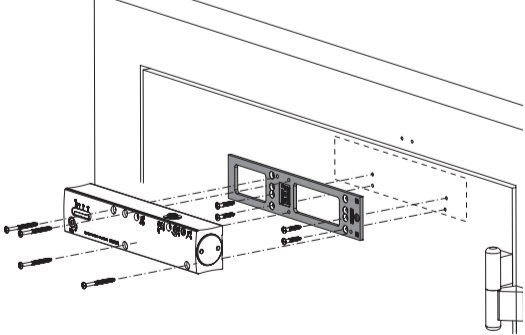
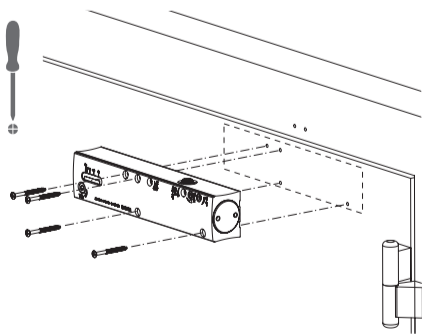

**4**

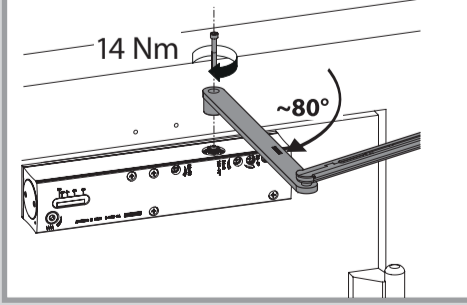
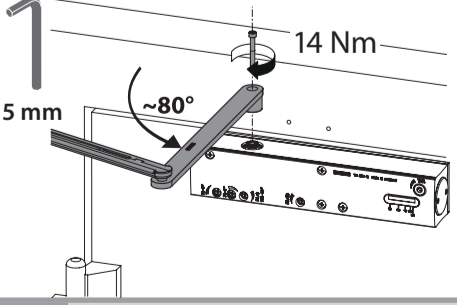

**5**

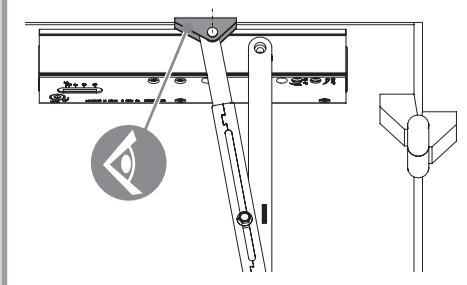
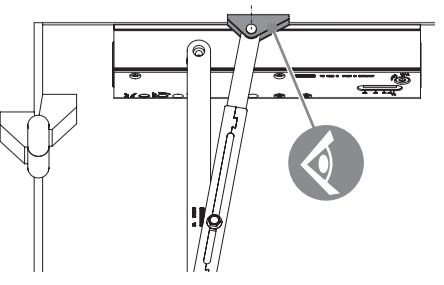

6



10 mm

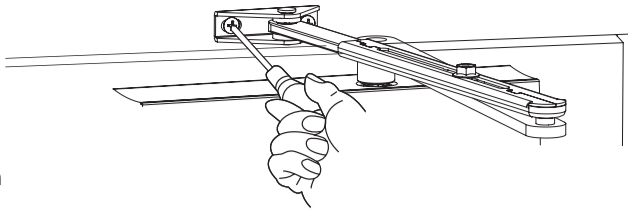

- 2x 5x20
- 2x M5x16



**TS 4000**

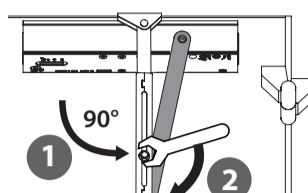
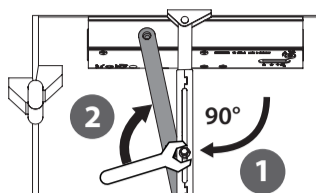
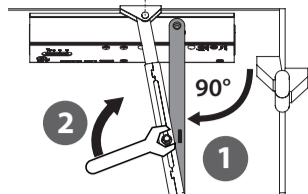
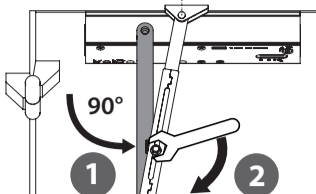
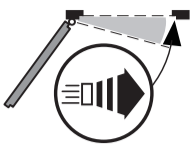

**TS 4000 S**

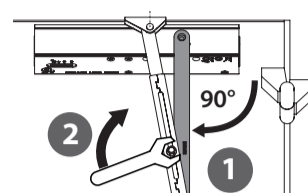
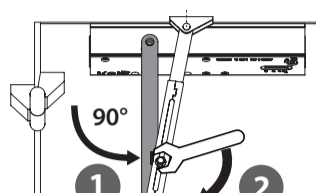

7



5 mm

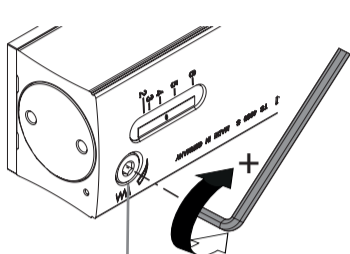
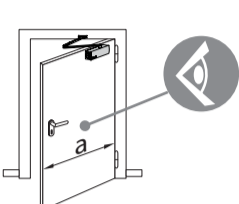

a (mm) - EN

- 1600 - 7
- 1400 - 6
- 1250 - 5
- 1150 - 4
- 950 - 3
- 850 - 2
- 750 - 1

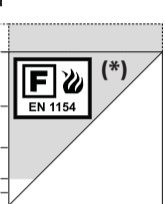

(\*) = + ≥ EN 3

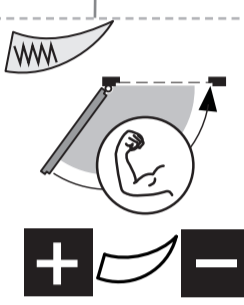

8

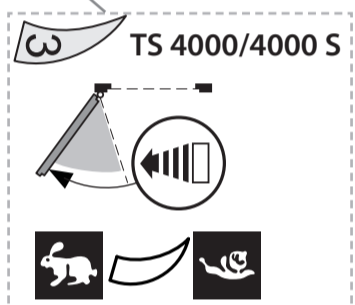
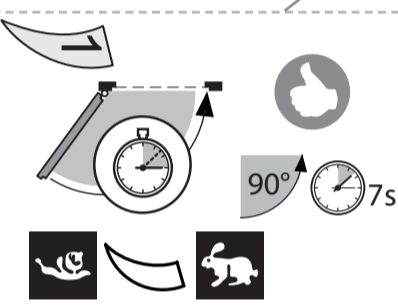

**TS 4000 S**

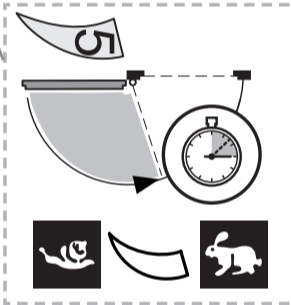
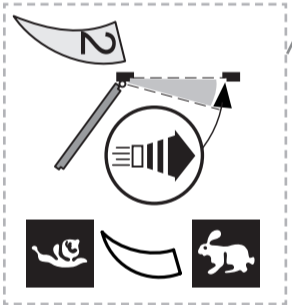
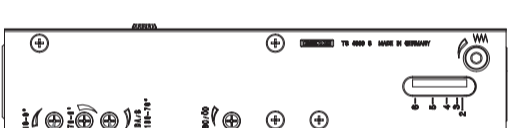

9

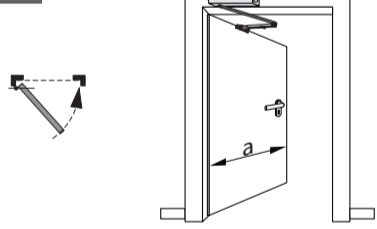
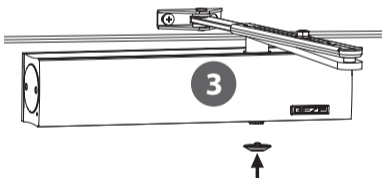
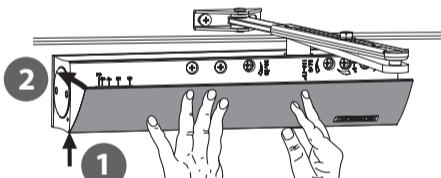

TS 4000/4000 S a ≤ 1400 mm  
TS 4000 EN 5-7 a ≤ 1600 mm

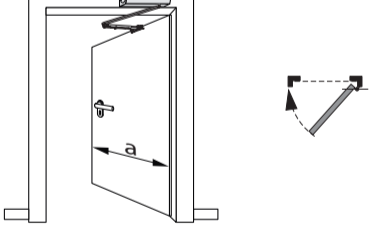

TS 4000/4000 S a ≤ 1400 mm  
TS 4000 EN 5-7 a ≤ 1600 mm

